

CDL-608C24

Operation and Specification

SUREN

PIR & Ultrasonic Occupancy Sensor

CDL-608C24 embodies the technology of infrared and ultrasonic motion detection into one easy-to-install occupancy sensor. Mounted at a height of 2.4m, this sensor detects people moving within 8m diameter of a full circular coverage area.

CDL-608C24 can be surface mounted or flush mounted for an attractive, un-obstructive appearance. One or many sensors can be connected with Suren's (or compatible) power packs to control a wide range of load types, including lighting or HVAC devices.

Operation

Initialization:

The sensor becomes operational 30 seconds after power is supplied.

Detection and Activation:

When a person enters a room, the sensor detects major body motion and turns the light on. The light is kept on even as smaller body movement is detected. The sensor's **Detection Sequence Logic (DSL)** minimizes false triggering by adjusting detection sensitivity based upon sequence of occupancy events. The **Sunset Sensor** provides additional control such that lighting is not activated when there is sufficient brightness in the area.

De-Activation (Normal Occupancy Mode):

When motion is no longer detected, the sensor turns the light off after a set time delay (Delayed-Off Time).

Walk-thru Mode:

The walk-through feature is useful in areas that are momentarily occupied, e.g. hallway. If the sensor detects no movement for more than 10 seconds light was turned off, it will apply a Delayed-Off Time of 2.5 minutes. If the sensor detects movement less than 10 seconds after light was turned off, it will next turn the light off based upon the set time delay.

Installation

Accessories:

- Brackets, screws and wall plugs for surface mount in solid ceiling
- Spring clips for flush mount in drop ceiling
- Infrared zone mask

Location:

- Determine the number of sensors required to cover the floor area
- Install the sensor near work area where walk-path cuts across radial lines, not towards the sensor
- Do not install the sensor near ventilation outlet
- Avoid facing the ultrasonic transceivers to each other to minimize interference

Procedure:

- Prepare sensor mount. See illustration in the next page
- Connect the sensor as shown in the wiring diagram. Make sure power supply is turned off
- Make sure there are no wiring exposed before mounting the sensor
- Mount the sensor and turn on the power supply
- Open the cover, review settings and change if necessary. See Settings section
- Initiate test mode, replace the cover and conduct walk-test

Walk-Test:

- Toggle dip switch B3 (Off-On-Off) to enter test mode. If B3 is already in the On position, moving it to the Off position will also activate test mode
- Amber LED will flash once every second when the sensor is in test mode
- During this time, the sensor will turn the light off after 5 seconds if there are no movement
- Test movement at entry point, walk path and occupancy area
- Sensor will exit test mode after 15 minutes

LED Indicator:

- LED indicator can be enabled or disabled by dip switch setting
- Recommended for troubleshooting
- Red LED indicates motion detected by infrared sensor
- Green LED indicates motion detected by ultrasonic sensor



Detection Area:

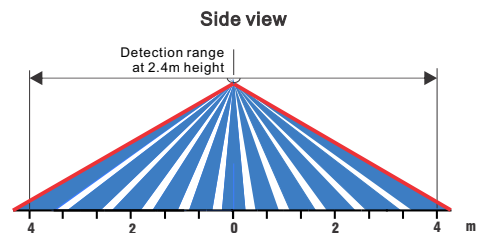
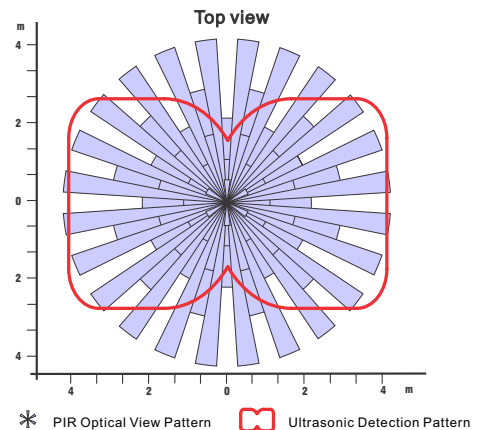

Wiring Diagram:

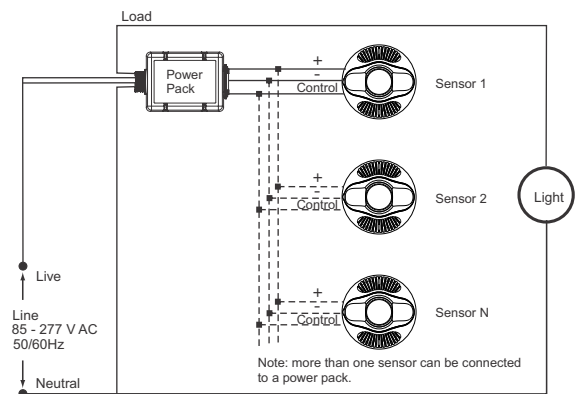

Specification

Power Supply:
24 V DC (Power pack PS-124 or PS-224 required)

Power Consumption:
0.96 W

Control Signal Output:
24 V DC, 15 mA

PIR Sensor:
Pyroelectric, 2-element

Ultrasonic Frequency:
40 KHz

Housing Material:
High-impact ABS

Dimension:
110mm Diameter x 56 mm Height

Operating Temperature Range:
-40° to 55° C

RF Immunity:
20 V/m 10-1000 Mhz; 10 V/m 1-2 GHz

Approvals:



Sensor Mounting Choices

The sensor may be mounted either in a drop-ceiling panel, or on a solid ceiling. In a drop-ceiling panel, two metal springs serve to retain the sensor in the panel. On a solid ceiling, the sensor is mounted on a base ring (supplied with the sensor). The base ring is fastened to the ceiling by means of three screws.

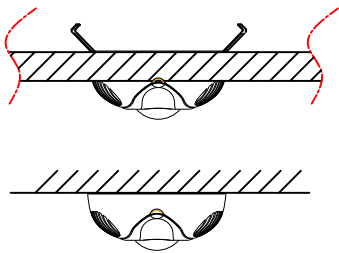

Drop-Ceiling Mounting: Base Preparation

Install the two retaining springs as shown.

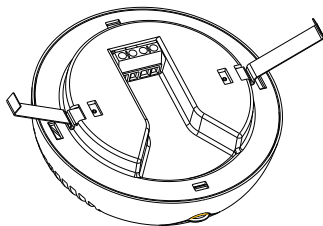

Drop-Ceiling Mounting: Panel Preparation

Use a hole saw to cut a 85 mm circular hole in the drop-ceiling panel at the desired location.

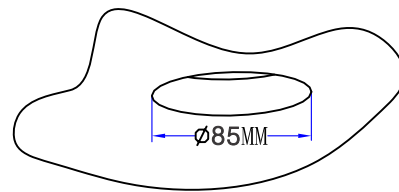

Drop-Ceiling Mounting: Sensor Installation

Press the retaining springs together, then push the springs and the sensor base through the hole until the sensor rim is seated against the panel.

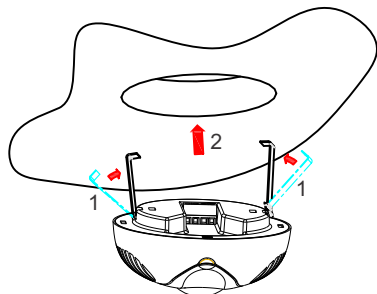

Solid-Ceiling Mounting

Use the three screws (supplied with the sensor) to fasten the base ring to the ceiling. Align the sensor's two eyelets with the base ring's two hooks. Press the sensor onto the base ring.

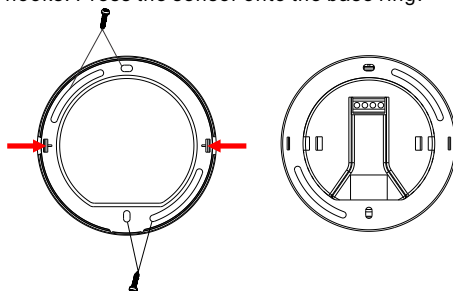

Note: The mounting clips indicated by the arrows represent the direction of the longer ultrasonic range shown in the Detection Area diagram.

Sensor Opening

Slide a fingertip under the tab at one end of the cover. Pull gently to remove the cover.

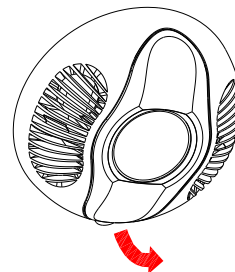

Operation Control Console

All aspects of sensor operation can be adjusted here.

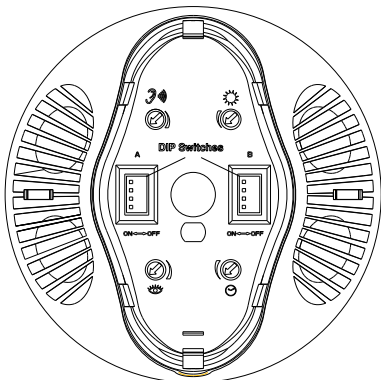

Ultrasonic Adjustment

For maximum range and sensitivity, set fully clockwise (CW). If reduced range and sensitivity are required, then turn counter-clockwise (CCW) and test.

Sets the ultrasonic range

Range setting
Full CCW = min.
Full CW = max.

Infrared Adjustment

For maximum range and sensitivity, set fully clockwise (CW). If reduced range and sensitivity are required, then turn counter-clockwise (CCW) and test.

Sets the infrared range

Range setting
Full CCW = min.
Full CW = max.

Delayed-Off Time Adjustment

The sensor turns light off if motion is not detected within the Delayed-Off Time interval. For less disruption, adjust clockwise (CW). For better energy savings, adjust counter-clockwise (CCW).

Delayed-Off Time

30sec 5min 10min 20min 30min

Sunset Sensor Adjustment

The sunset sensor saves energy by not switching the light on when there is sufficient daylight in the room. It can be enabled or disabled by the dip switch B1. When the sunset sensor is enabled, the sensor goes into stand-by mode when the natural light level exceeds the selected Lux level inhibiting the light from turning on. To set the Lux level, draw curtains or shades until the room is at the darkness that light should be turned on. Adjust the Lux level from low to high until lighting is activated. Note that the sunset sensor is disabled when the occupancy sensor is in test mode.

Ambient Light

20Lux 40Lux 80Lux 160Lux 320Lux

Dip Switch Settings

Dip Switch	Function	Settings	
		Off	On
Bank A			
A1	Multi/Single Technology	Features enabled by the combination of	
A2	Technology Activated	A1 & A2 are shown in the table below.	
A3	Not Used		
A4	Walk-Thru/Normal	Walk-Thru Enabled	Normal Occupancy
Bank B			
B1	Sunset Sensor	Enabled	Disabled
B2	LED Indicator	Enabled	Disabled
B3	Test Mode	Off-On-Off / On-Off	
B4	Not Used		

A1	A2	Feature
Off	Off	PIR technology turns light on; however, motion detection by either technology will keep the light on. If neither technology detects motion, the light turns off after the Delayed-Off time. [Choose this option to reduce false activation due to ultrasonic technology.]
Off	On	PIR or Ultrasonic technology turns light on and keeps light on. If neither technology detects motion, the light turns off after the Delayed-Off time. [Default]
On	Off	Only PIR technology is active.
On	On	Only Ultrasonic technology is active.